



Datasheet

LED 1w Power



Блок линз 3LB50D (50deg, 3X LED)



LIGHTING PARAMETERS

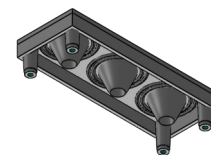
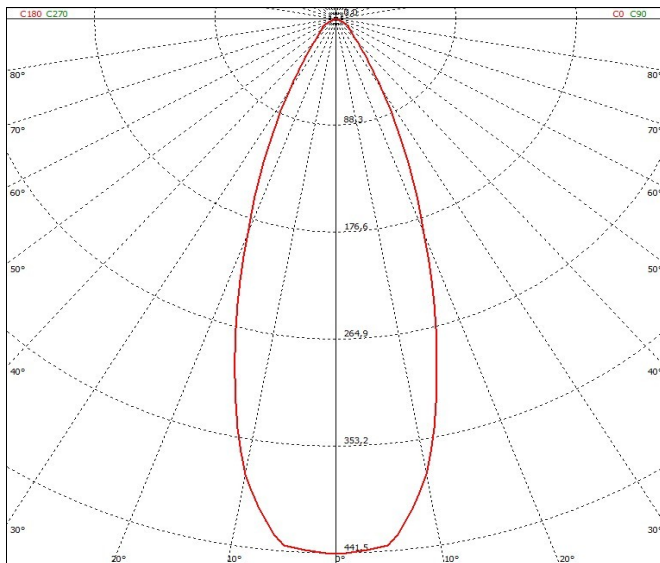
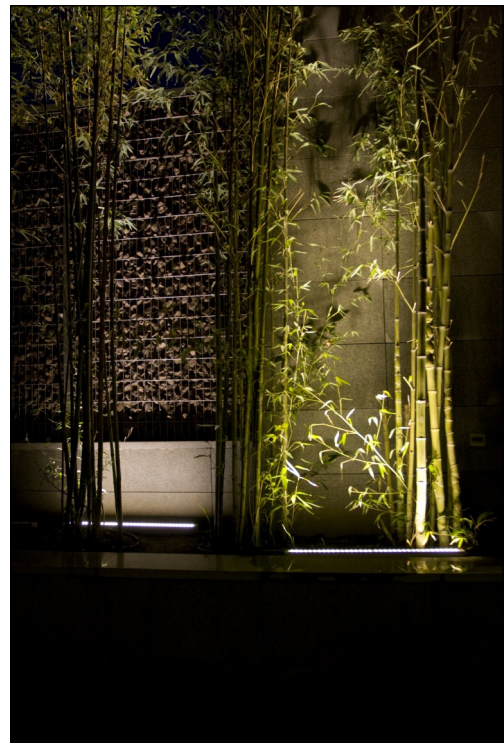
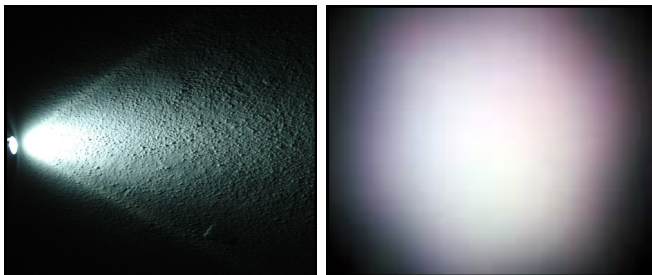

Box Quantity : 216 PCS
 Box Size : 25*25*16 cm
 Box Total Kg +/-%3: 3,30 Kg **PACKAGING**

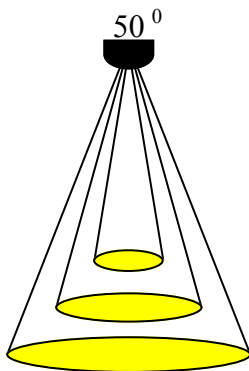
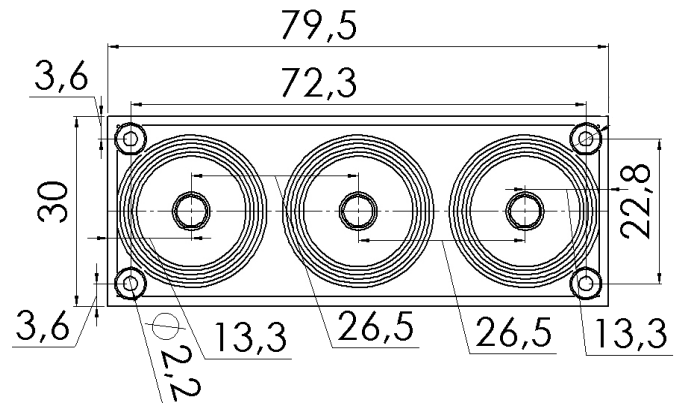
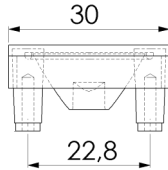

50 Degree

Light Dimension Parameters

- 1m / ϕ : 0,94 m
- 2m / ϕ : 1,88 m
- 3m / ϕ : 2,82 m

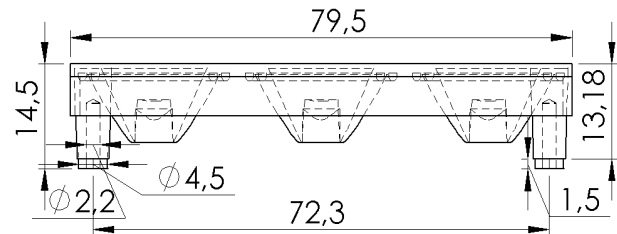

*** Lens Use**

- * Streets, Offices, Homes, Stages, Architectural, Down Light , & Decorative Lighting

*** Lens Material**

- * Optical Grade PMMA / PC Best Available Optical Efficiency : > 90 % ,PMMA with UV Light Transmittance High Productivity with 2mm Thickness
- * Operating Temperature: -40°C ~ + 80°C (upper limit +90°C) PMMA
- * Operating Temperature: -40°C ~ + 90°C (upper limit +100°C) PC
- * Average transmittance in visible spectrum: 400nm~700nm> 90% - (3mm thick PMMA)

*** Holder information**

- * Operating Temperature: -40°C ~ + 110°C PC V2 & ROHS UV Resistant
- Flammability Standard : V2 (burning stops within 30 seconds on a vertical specimen; drips of flaming particles are allowed). High heat resistance

***Assembly Information**

- * If adhesive is used, make sure that the adhesive is acid-free.
- * If you need to clean the lenses, use only mild soap and water. Use a very soft piece of cloth to dry.
- * Do not use any solvents on lenses
- * Our product is guaranteed against manufacturing defects only.
- * Do not store the product in a dusty & corrosive environment
- * Do not touch the optical portion of the lens with bare hands